

Com.X IAG brochure

Integrated Access Gateway



farsouth networks 

Access a new world of feature rich, connected anywhere telephony, at low cost and low risk



Voice, Data & Web Services Convergence

- “3-in-One“: Router/Firewall + IP Gateway + (optional) PBX
- Managed Voice and Data services
-  wanderweb.net Web Real Time Communication services

“3-in-One” SOHO to SMME Business Solution

- **Zero hardware obsolescence:** Flexible, high availability, secure IP Gateway Router supports migration to “in-the-box” PBX
- **Enhanced Service Levels / Reduce support costs:** Secure web access integrating reporting and diagnostic tools

The Integrated Communicator

- **Managed Services:**  wanderweb.net ready, for secure, host portal to connect, provision and maintain ANY Com.X device on ANY network
- **Data:** Router, Firewall, Networking, QoS
- **Telecoms:** Analogue (FXS, FXO), ISDN (BRI, PRI)
- **VoIP:** SIP (TCP & UDP), IAX2
- **WebRTC**
- **Broadband IP:** ADSL2+, X.21, Ethernet
- **Fixed Wireless Access:** 3G or LTE
- **Software upgrade:** path to “PBX in the box”

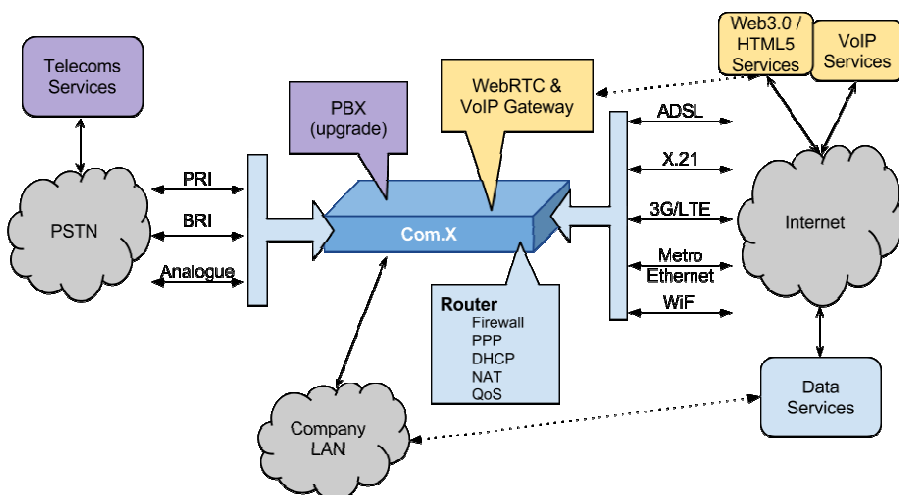

- **Protocols:** HDLC, PPP/PPPoE, IPv4
- **Networking:** DDNS, DHCP, VPN, NTP, SSH, HTTP, VLAN
- **Router:** NAT & NAT traversal, SIP ALG, Port forwarding
- **Firewall:** Policy and Access Control Lists, Filters, DMZ
- **QoS:**
 - Class of Service:
 - VLAN Priority Code Points, IEEE 802.1P
 - Differentiated Services Code Points (DSCP)
 - Traffic Shaping (upgrade path)
 - Quality of Service: ViBE integration
- **IP Gateway**
 - WebRTC, SIP, Analogue, ISDN
 - Back-to-Back User Agent (B2BUA)
 - Call Recording, on device
- **PBX upgrade**
 - Unified communications feature set
 - Analogue, DECT & IP phone support
- **Seamless telephony port expansion via LAN based Comma iTA**

Main features

- **Rack or Desk-mount**
- **Managed Services:**  wanderweb.net Connect, Provision, Monitor centrally via secure host portal
- **CODEC's:** Opus, G.729a, G.723, G.711, G.726, ILBC
- **Interfaces:** IP (WebRTC & SIP), Analogue, BRI, PRI
- **LAN / WAN:**
 - ADSL2+ (RJ-11)
 - X.21 (DB15)
 - 4-port Gigabit Ethernet (RJ-45)
 - 802.11 a/b/g Access Point
- **Fixed Mobile Access:** 3G/LTE, 1 SIMM, external antenna
- **T.38 fax**
- **Diagnostics tools:** SIPp & Wireshark
- **On-line, remote software updates**
- **Certification:** TBR3, TBR4, TE-001, EN60950, CISPR22
- **South African design & manufacture**
- **1-year h/w warranty & 1-year s/w assurance**
- **ICASA type approval**
- **Neotel approved**

www.farsouthnet.com



Copyright © 2007-2016 Far South Networks (Pty) Ltd
Intel and the Intel logo are trademarks of Intel Corporation U.S. and/or other countries

Com.X IAG brochure Integrated Access Gateway

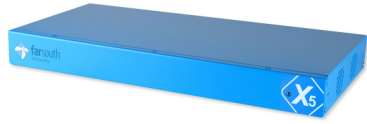
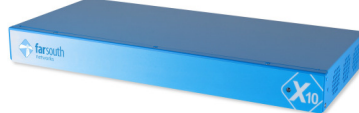

farsouth 
networks

Com.X Short-form Specification

	Com.X5 Lite	Com.X5		Com.X10	Com.X20
Product Image					
Market	SOHO	Smaller SMME		Larger SMME	Enterprise
Users	5 to 20	20 to 50	50 to 100	100 to 450	450 to 1000
Maximum external calls	4	8	16	30, 60, 90 & 120	360
Server Specification	Intel Atom E620 600MHz RAM: 512MB DDR2		Intel Atom E660 1.3GHz RAM: 512MB DDR2	Intel Bay Trail N2930 CPU Quad core 1.83GHz RAM: 4GB DDR3	Intel i7-3612QE CPU RAM: 8GB DDR3
Maximum G.729a CODEC's	4	8	16	30, 60, 90 & 120	360
Non-volatile Memory Capacity	16GB SD		64GB SSD, or 500GB RAID 1 HDD	64GB MSATA Optional: Dual 1TB RAID 1 HDD	128GB SSD, or Dual 1TB RAID 1 HDD
Form-factor	Half 19" x 1U	19" x 1U		19" x 1U	Multiple 19" x 1U
Extensions	IP 2 to 4 analogue (FXS)	IP 2 to 24 analogue (FXS)		IP 2 to 8 analogue (FXS)	IP 100's analogue (FXS)
Trunks	SIP 2 to 4 analogue (FXO) 2 BRI	SIP 2 to 24 analogue (FXO) 4 to 8 BRI		SIP 2 to 8 FXO 4 to 8 BRI 1 to 2 PRI	SIP 100's analogue (FXO) Multiple BRI (Up to) 12 PRI
WAN	-	X.21 (1984kbps max) GbE 3G, LTE (1 SIMM) ADSL2+		X.21 (1984kbps max) GbE	GbE
Fixed Wireless	HSPA+ 21Mbps (850/900/1900/2100 MHz) LTE 100Mbps (800/900/1800/2100/2600 MHz)			-	-
Telephony Expansion	Unlimited, refer to Comma iTA product page				
Ports	4 * 100/1000Base-Tx USB2.0: 2			2 to 3 * 100/1000Base-Tx USB2.0: 2	4 * 100/1000Base-Tx USB2.0: 6
Mount	1U rack or desk mount			1U rack or desk mount	19" rack mount
Dimensions	225mm x 200mm x 44mm	445mm x 200mm x 44mm		427mm x 200mm x 44mm	
Power Supply	12Vdc, 2.5A via ext AC/DC adapter		12Vdc, 5A via ext AC/DC adapter	12Vdc, 5A via ext AC/DC adapter	220V, 50Hz & 12Vdc, 5A ext AC/DC adapter
Maximum recorded channels	4 (SD card)	8 (SD card)	16 (SATA drive)	30, 60, 90 & 120	360
Recording Capacity	SD: 100,000 min (gsm format) SSD: 500,000 min (gsm format) HDD: 1,000,000 min (A-law format)			SSD: 500,000 minutes (gsm format) HDD: 1,000,000 minutes (A-law format)	SSD: 1,000,000 minutes (gsm format) HDD: 1,000,000 minutes (A-law format)

For up to date product news and insights, follow us at: <http://www.linkedin.com/company/far-south-networks>

www.farsouthnet.com

Copyright © 2007-2016 Far South Networks (Pty) Ltd
Intel and the Intel logo are trademarks of Intel Corporation U.S. and/or other countries